

# Data Sheet



Article number: 1080401111000  
Description: Servocontroller ACU401-11-FA  
1,5 kW 3,3A 3x400V IP20

## Measures

---

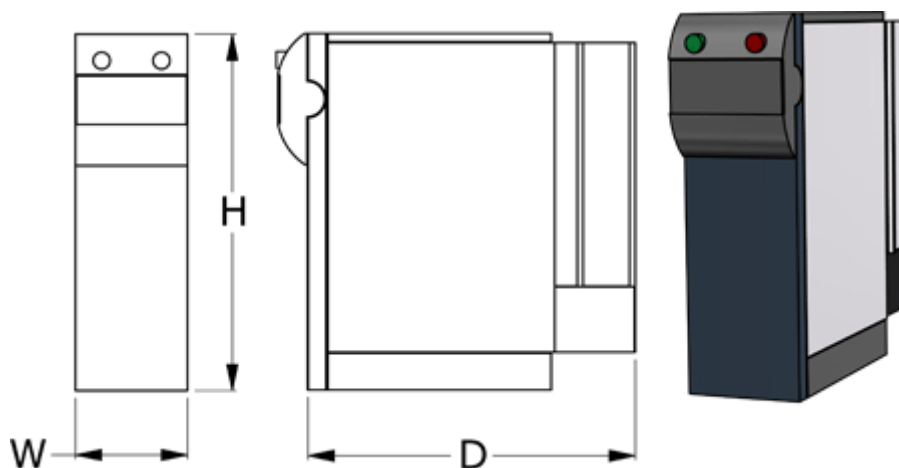

D = 175  
H = 190  
W = 60  
Weight = 1.2